

# RF Peaking Coils - PK 0608 - PK 0810 - PK1012 Series



- Excellent Q, high SFR
- Radial mounting
- Small size
- PVC sleeving or UL tube
- Operating temperature range: -20 °C to +80 °C

## Specifications

- Inductance range: 1.0 to 100mH
- Current rating: Based on max temp rise not exceeding 20 °C
- Terminal strength: 0.5Kg min

## Electrical Data

Part Number	L @ 1kHz (mH ± 10%)	Q min	Q Test freq (MHz)	Rdc (Ω) max	Idc (mA) max
PK0608-122K-S	1.2	70	252	3.5	120
PK0608-152K-S	1.5	70	252	4.5	100
PK0608-182K-S	1.8	70	252	5.0	100
PK0608-222K-S	2.2	70	252	6.2	90
PK0608-272K-S	2.7	70	252	7.2	90
PK0608-332K-S	3.3	70	252	10.5	60
PK0608-392K-S	3.9	70	252	11.7	60
PK0608-472K-S	4.7	70	252	13.6	60
PK0608-562K-S	5.6	70	252	16.6	50
PK0608-682K-S	6.8	70	252	19.6	50
PK0608-822K-S	8.2	70	252	25.2	40
PK0608-103K-S	10	70	79.6	29.5	40
PK0608-123K-S	12	70	79.6	33.8	40
PK0608-153K-S	15	70	79.6	45.4	30
PK0608-183K-S	18	70	79.6	50.4	30
PK0608-223K-S	22	70	79.6	60	30
PK0608-303K-S	30	70	79.6	91.5	20
PK0608-333K-S	33	70	79.6	98.5	20
PK0608-393K-S	39	70	79.6	140	15
PK0608-473K-S	47	70	79.6	160	15
PK0608-503K-S	50	70	79.6	170	15
PK0608-563K-S	56	70	79.6	181	15
PK0608-683K-S	68	50	79.6	282	15
PK0608-823K-S	82	50	79.6	312	10
PK0608-104K-S	100	30	25.2	380	10
PK0608-124K-S	120	30	25.2	430	10
PK0608-154K-S	150	30	25.2	520	10

Part Number	L @ 1kHz (mH ± 10%)	Q min	Q Test freq (MHz)	SRF (MHz) min	Rdc (Ω) max	Idc (mA) max
PK0810-102K-S	1.0	65	0.252	1.4	6.0	450
PK0810-122K-S	1.2	140	0.252	1.2	6.0	450
PK0810-152K-S	1.5	130	0.252	1.1	7.0	400
PK0810-162K-S	1.6	150	0.252	1.1	10	400
PK0810-182K-S	1.8	150	0.252	1.1	10	400
PK0810-222K-S	2.2	150	0.252	1.0	12	360
PK0810-272K-S	2.7	140	0.252	0.9	14	360
PK0810-302K-S	3.0	140	0.252	0.9	15	280
PK0810-332K-S	3.3	140	0.252	0.86	16	280
PK0810-392K-S	3.9	130	0.252	0.81	18	280
PK0810-472K-S	4.7	120	0.252	0.77	20	260
PK0810-562K-S	5.6	120	0.252	0.72	22	260
PK0810-682K-S	6.8	110	0.252	0.54	29	260
PK0810-752K-S	7.5	110	0.252	0.52	30	240
PK0810-822K-S	8.2	100	0.252	0.50	30	240

PK1012-103K-S	10	140	79.6	0.35	12	280
PK1012-123K-S	12	140	79.6	0.31	13	280
PK1012-153K-S	15	140	79.6	0.28	18	280
PK1012-183K-S	18	130	79.6	0.26	25	280
PK1012-223K-S	22	130	79.6	0.22	30	240
PK1012-273K-S	27	130	79.6	0.20	35	240
PK1012-333K-S	33	110	79.6	0.19	40	200
PK1012-393K-S	39	110	79.6	0.17	50	140
PK1012-473K-S	47	110	79.6	0.15	50	140
PK1012-563K-S	56	100	79.6	0.13	65	140
PK1012-683K-S	68	80	79.6	0.12	70	120
PK1012-823K-S	82	65	79.6	0.10	85	120
PK1012-104K-S	100	60	79.6	0.10	100	120

	ØA max	B max	C	D max	ØE +/-0.05	F
PK0608	7.0	10.0	15.0	1.5	0.65	2.5 ±0.5
PK0810	9.0	12.5	15.0	1.5	0.65	5 ±1.0
PK1012	12.0	14.0	15.0	1.5	0.80	6 ±1.0

### T/F Type

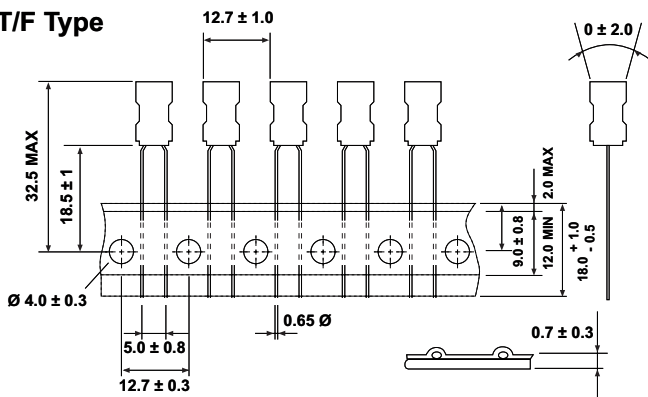

### TF Type

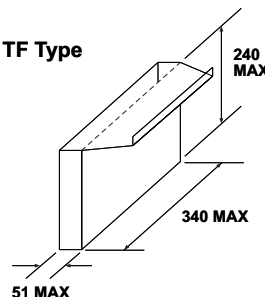

Part Number	Packaging quantity
PK0608	1300 pcs
PK0810	600 pcs
PK1012	500 pcs

...Industrial Technologies...  
 ...Power Magnetics...  
 ...Leaded Energy Storage and Filtering Inductors



# Axial Lead Power Chokes - VC 0513 Series



- PVC heat-shrink insulation 2.5kV isolation
- Low DC resistance
- DC current rating up to 1.28A
- Inductance range 3.9  $\mu$ H to 18000  $\mu$ H  $\pm$  10 %
- Ferrite core, rugged construction
- Tape and reel 1000 pcs/reel, or bulk
- Operating temperature range: -40 °C to +105 °C

Construction Isolated enamelled copper wire over ferrite core with PVC shrink sleeving.

## Electrical Data

Part Number	Inductance at 1 KHz (mH $\pm$ 10%)	Rdc Max ( $\Omega$ )	Saturation Current (A)	dc Current (A)
VC-0513-3R9K-PVC	3.9	0.019	7.3	1.28
VC-0513-4R7K-PVC	4.7	0.022	6.3	1.28
VC-0513-5R6K-PVC	5.6	0.024	5.6	1.28
VC-0513-6R8K-PVC	6.8	0.026	5.3	1.28
VC-0513-8R2K-PVC	8.2	0.028	4.5	1.28
VC-0513-100K-PVC	10	0.033	4.1	1.28
VC-0513-120K-PVC	12	0.037	3.6	1.28
VC-0513-150K-PVC	15	0.040	3.3	1.28
VC-0513-180K-PVC	18	0.044	3.0	1.28
VC-0513-220K-PVC	22	0.050	2.7	1.28
VC-0513-270K-PVC	27	0.058	2.5	1.28
VC-0513-330K-PVC	33	0.075	2.2	1.008
VC-0513-390K-PVC	39	0.094	2.0	0.804
VC-0513-470K-PVC	47	0.109	1.8	0.804
VC-0513-560K-PVC	56	0.140	1.7	0.804
VC-0513-680K-PVC	68	0.145	1.5	0.804
VC-0513-820K-PVC	82	0.152	1.4	0.804
VC-0513-101K-PVC	100	0.208	1.2	0.632
VC-0513-121K-PVC	120	0.283	1.1	0.508
VC-0513-151K-PVC	150	0.340	1.0	0.508
VC-0513-181K-PVC	180	0.362	0.95	0.508
VC-0513-221K-PVC	220	0.430	0.86	0.508
VC-0513-271K-PVC	270	0.557	0.77	0.400
VC-0513-331K-PVC	330	0.665	0.70	0.400
VC-0513-391K-PVC	390	0.772	0.64	0.400
VC-0513-471K-PVC	470	1.15	0.59	0.315
VC-0513-561K-PVC	560	1.27	0.54	0.315
VC-0513-681K-PVC	680	1.61	0.49	0.250
VC-0513-821K-PVC	820	1.96	0.44	0.200
VC-0513-102K-PVC	1000	2.30	0.40	0.200
VC-0513-122K-PVC	1200	2.65	0.35	0.200
VC-0513-152K-PVC	1500	3.45	0.33	0.158
VC-0513-182K-PVC	1800	4.03	0.29	0.158
VC-0513-222K-PVC	2200	4.48	0.27	0.158
VC-0513-272K-PVC	2700	5.90	0.24	0.125
VC-0513-332K-PVC	3300	6.56	0.22	0.125
VC-0513-392K-PVC	3900	8.63	0.20	0.100
VC-0513-472K-PVC	4700	10.5	0.18	0.100
VC-0513-562K-PVC	5600	13.9	0.166	0.082
VC-0513-682K-PVC	6800	16.3	0.151	0.082
VC-0513-822K-PVC	8200	20.8	0.136	0.065
VC-0513-103K-PVC	10000	26.4	0.125	0.050
VC-0513-123K-PVC	12000	29.2	0.114	0.050
VC-0513-153K-PVC	15000	42.5	0.098	0.039
VC-0513-183K-PVC	18000	48.3	0.091	0.039

## Typical Dimensions (mm)

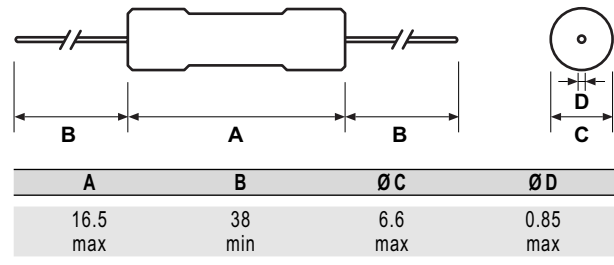

## Tape and reel specifications

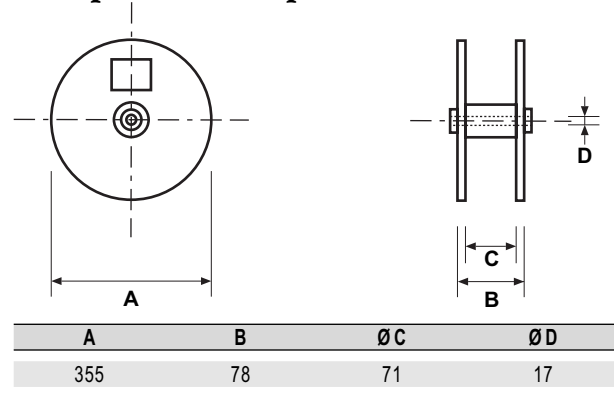

## To Order

VC	0513	###	K	PVC
Type	Core size	Inductance	Tolerance K for $\pm$ 10%	PVC sleeving

VC 0513 ###K PVC

**Packaging** Tape and Reel: 1000 pieces



# Axial Lead Power Chokes - VC 1019 Series

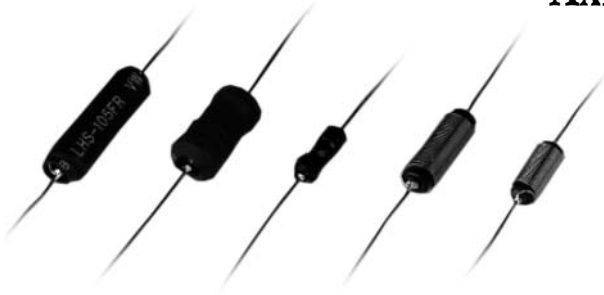

- PVC (UL) heat-shrink insulation 2.5kV isolation
- Low DC resistance
- DC current range to 4A
- 3.9 $\mu$ H to 100000 $\mu$ H
- Ferrite core, rugged construction
- Operating temperature range: -40 °C to +105 °C

## Electrical Data

Part Number	Inductance at 1 KHz (mH $\pm$ 10%)	Rdc Max ( $\Omega$ )	Saturation Current (A)	dc Current (A)
VC-1019-3R9K-UL	3.9	0.007	15.5	4.0
VC-1019-4R7K-UL	4.7	0.008	13.9	4.0
VC-1019-6R8K-UL	6.8	0.011	11.6	4.0
VC-1019-100K-UL	10	0.017	8.70	4.0
VC-1019-150K-UL	15	0.022	7.34	4.0
VC-1019-220K-UL	22	0.026	6.07	4.0
VC-1019-270K-UL	27	0.027	5.36	4.0
VC-1019-330K-UL	33	0.032	4.82	4.0
VC-1019-390K-UL	39	0.033	4.36	4.0
VC-1019-470K-UL	47	0.035	3.98	4.0
VC-1019-560K-UL	56	0.037	3.66	3.2
VC-1019-680K-UL	68	0.047	3.31	2.5
VC-1019-820K-UL	82	0.060	3.10	2.0
VC-1019-101K-UL	100	0.090	2.79	1.6
VC-1019-121K-UL	120	0.113	2.54	1.6
VC-1019-151K-UL	150	0.129	2.22	1.6
VC-1019-181K-UL	180	0.150	1.98	1.6
VC-1019-221K-UL	220	0.162	1.89	1.6
VC-1019-271K-UL	270	0.208	1.63	1.6
VC-1019-331K-UL	330	0.212	1.51	1.6
VC-1019-391K-UL	390	0.281	1.39	1.6
VC-1019-471K-UL	470	0.380	1.24	1.2
VC-1019-561K-UL	560	0.420	1.17	1.0
VC-1019-681K-UL	680	0.548	1.05	1.0
VC-1019-821K-UL	820	0.655	0.97	0.8
VC-1019-102K-UL	1000	0.884	0.87	0.8
VC-1019-122K-UL	1200	1.04	0.79	0.6
VC-1019-152K-UL	1500	1.18	0.70	0.6
VC-1019-182K-UL	1800	1.56	0.64	0.6
VC-1019-222K-UL	2200	2.00	0.58	0.5
VC-1019-272K-UL	2700	2.06	0.53	0.4
VC-1019-332K-UL	3300	2.53	0.47	0.4
VC-1019-392K-UL	3900	2.75	0.43	0.4
VC-1019-472K-UL	4700	3.19	0.39	0.4
VC-1019-562K-UL	5600	3.92	0.359	0.315
VC-1019-682K-UL	6800	5.69	0.322	0.250
VC-1019-822K-UL	8200	6.32	0.293	0.250
VC-1019-103K-UL	10000	7.30	0.266	0.250
VC-1019-153K-UL	15000	10.5	0.214	0.200
VC-1019-223K-UL	22000	21.8	0.180	0.125
VC-1019-333K-UL	33000	25.7	0.146	0.125
VC-1019-473K-UL	47000	36.1	0.122	0.100
VC-1019-683K-UL	68000	57.3	0.101	0.082
VC-1019-104K-UL	100000	89.7	0.081	0.065

## Typical Dimensions (mm)

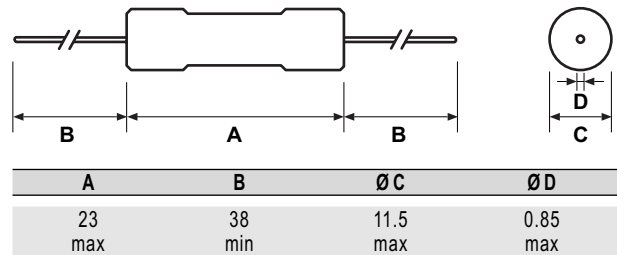

## To Order

VC	1019	###	K	UL
Type	Core size	Inductance	Tolerance K for $\pm$ 10%	UL sleeving

Packaging Bulk



# Toroidal Chokes - TC Series

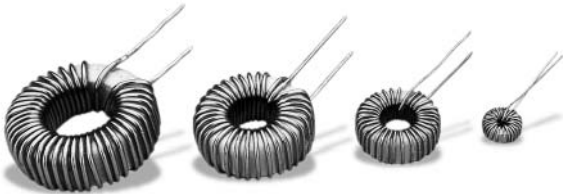

- Inductance range from 4,9  $\mu\text{H}$  to 1130  $\mu\text{H}$
- Inductance tolerance: M:  $\pm 20\%$ , K:  $\pm 10\%$
- Iron powder core material
- Operating temperature range:  $-55^\circ\text{C}$  to  $+105^\circ\text{C}$
- Weight: 0.2 to 82 grams

## Electrical Data

ID Code	DC Current (A)	Inductance ( $\mu\text{H}$ ) ldc : 0	Inductance ( $\mu\text{H}$ ) rated ldc	Rdc (m $\Omega$ )	Dimensions D x W (mm)
TC-270M-0.1A-2026	0.1	27	27.0	33	7.5 x 4.5
TC-200M-0.2A-2026	0.2	20	19.8	198	7.5 x 4
TC-9R0M-0.3A-2026	0.3	9	8.8	11	8 x 4.5
TC-270M-0.3A-2026	0.3	27	25.5	31	8 x 4.5
TC-5R0M-0.5A-2026	0.5	5	4.9	7	7.5 x 4.5
TC-150M-0.5A-2026	0.5	15	13.5	70	7.5 x 4.5
TC-370M-0.5A-3026	0.5	37	33.7	134	10 x 5.5
TC-560M-0.5A-3726	0.5	56	53.0	181	12.5 x 5.5
TC-111M-0.5A-4426	0.5	110	100.0	250	14 x 6.5
TC-141M-0.5A-3026	0.5	140	107.0	265	10 x 6
TC-241M-0.5A-3726	0.5	240	190.0	360	13 x 6.5
TC-361M-0.5A-4426	0.5	360	285.0	460	14.5 x 7.5
TC-120M-1A-3026	1.0	12	10.7	40	10.5 x 6
TC-240M-1A-3726	1.0	24	22.0	55	13.5 x 6
TC-320M-1A-3026	1.0	32	25.0	65	12 x 7
TC-430M-1A-4426	1.0	43	37.0	74	14.5 x 7
TC-680M-1A-3726	1.0	68	53.0	95	13.5 x 6.5
TC-131M-1A-6026	1.0	68	60.0	101	16 x 7.5
TC-141M-1A-4426	1.0	130	116.0	146	19 x 9
TC-151M-1A-6826	1.0	140	104.0	140	15 x 7.5
TC-221M-1A-5026	1.0	150	137.0	159	21.5 x 7.5
TC-471M-1A-6026	1.0	220	162.0	190	16.5 x 8
TC-471M-1A-9026	1.0	470	310.0	286	21 x 11
TC-471M-1A-9426	1.0	470	398.0	354	26.5 x 13
TC-501M-1A-6826	1.0	470	400.0	342	27.5 x 11.5
TC-961M-1A-8026	1.0	500	355.0	300	22 x 9
TC-132M-1A-9426	1.0	960	625.0	438	25 x 11
TC-182M-1A-9026	1.0	1300	933.0	585	28.5 x 12.5
TC-8R2M-2A-3726	2.0	1800	1130.0	680	27.5 x 14
TC-100M-2A-3026	2.0	8.2	7.2	17	14.5 x 7
TC-120M-2A-3026	2.0	10	7.7	17	12 x 7
TC-150M-2A-4426	2.0	15	12.6	23	15.5 x 7.5
TC-220M-2A-3726	2.0	22	17	30	14.5 x 7.5
TC-300M-2A-5026	2.0	30	25.0	35	17 x 8.5
TC-580M-2A-6026	2.0	58	45.0	61	20 x 10
TC-650M-2A-6826	2.0	65	55.0	55	22 x 9
TC-680M-2A-4426	2.0	68	42.0	56	15.5 x 9
TC-101M-2A-5026	2.0	100	63.0	81	17 x 9
TC-111M-2A-6026	2.0	110	79.0	69	19.5 x 10
TC-111M-2A-8026	2.0	110	90.0	74	25 x 10
TC-201M-2A-9026	2.0	200	154.0	114	28 x 14
TC-221M-2A-9426	2.0	220	170.0	121	28.5 x 12
TC-231M-2A-6826	2.0	230	148.0	108	22.5 x 9.5
TC-301M-2A-10626	2.0	300	250.0	142	31.5 x 15.5
TC-321M-2A-8026	2.0	320	193.0	131	25 x 10.5
TC-431M-2A-8026	2.0	430	246.0	150	25 x 11
TC-451M-2A-9026	2.0	450	280.0	174	28 x 14
TC-781M-2A-9426	2.0	780	428.0	225	28.5 x 13.5
TC-851M-2A-10626	2.0	850	567.0	211	32.5 x 16.5
TC-200M-2A-5026	3.0	20	15.0	21	17.5 x 9
TC-350M-3A-6026	3.0	35	28.0	26	20.5 x 10.5
TC-430M-3A-6826	3.0	43	30.0	30.0	23 x 9.5

ID Code	DC Current (A)	Inductance ( $\mu\text{H}$ ) ldc : 0	Inductance ( $\mu\text{H}$ ) rated ldc	Rdc (m $\Omega$ )	Dimensions D x W (mm)
TC-600M-3A-5026	3	60	30	38	18 x 10
TC-750M-3A-8026	3	75	54	39	25.5 x 11
TC-820M-3A-8026	3	82	60	42	24.5 x 10.5
TC-900M-3A-6026	3	90	52.5	44	20.5 x 12.5
TC-131M-3A-6826	3	130	77	55	23 x 10.5
TC-131M-3A-9426	3	130	96	61	29 x 13
TC-141M-3A-9026	3	140	98	64	28 x 14.5
TC-201M-3A-10626	3	200	157	78	32 x 16
TC-271M-3A-8026	3	270	140	81	26 x 12
TC-471M-3A-9026	3	470	225	118	28.5 x 15.5
TC-501M-3A-9426	3	500	242	124	29 x 14
TC-290M-4A-6026	4	29	20	20	21 x 11
TC-320M-4A-6826	4	32	24	21	23.5 x 10
TC-600M-4A-8026	4	60	42	30	26.5 x 11.5
TC-101M-4A-9426	4	100	69	42	29.5 x 13.5
TC-111M-4A-6826	4	110	56	42	23.5 x 11
TC-151M-4A-10626	4	150	110	53	32.5 x 16.5
TC-221M-4A-8026	4	220	105	59	26.5 x 13
TC-391M-4A-9426	4	390	165	88	29.5 x 15
TC-220M-5A-6026	5	22	15	14	21.5 x 11.5
TC-250M-5A-6826	5	25	18	16	24 x 10.5
TC-500M-5A-8026	5	50	33	22	26.5 x 12
TC-820M-5A-9426	5	82	52	33	31 x 15.5
TC-900M-5A-9026	5	90	54	34	29.5 x 15.5
TC-101M-5A-8026	5	100	53	33	26.5 x 12.5
TC-101M-5A-10626	5	100	75	36	33.5 x 17
TC-151M-5A-8026	5	150	68	42	27 x 13.5
TC-201M-5A-13026	5	200	134	56	39 x 17
TC-301M-5A-9426	5	300	120	64	30 x 15.5
TC-321M-5A-9026	5	320	120	68	29.5 x 17
TC-681M-5A-13026	5	680	295	105	39 x 18.5
TC-560M-7A-10626	7	56	41.5	20	34 x 18
TC-680M-7A-10626	7	68	46	21	34 x 18
TC-820M-7A-10626	7	82	53	23	34 x 18
TC-131M-7A-13026	7	130	79	31	41 x 18
TC-471M-7A-13026	7	470	190	64	40.5 x 19.5
TC-300M-10A-10626	10	30	21	9	36 x 19.5
TC-350M-10A-10626	10	35	25	10	36 x 19.5
TC-750M-10A-13026	10	75	43	14	42 x 19.5
TC-251M-10A-13026	10	250	105	27	42.5 x 21.5

## Typical Dimensions (mm - see tables)

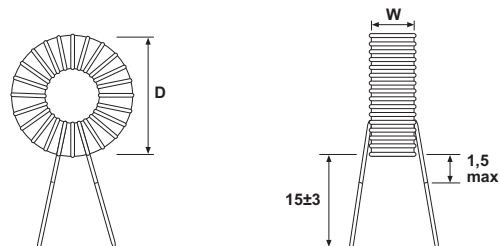

# Energy Storage Inductors - ESI Series

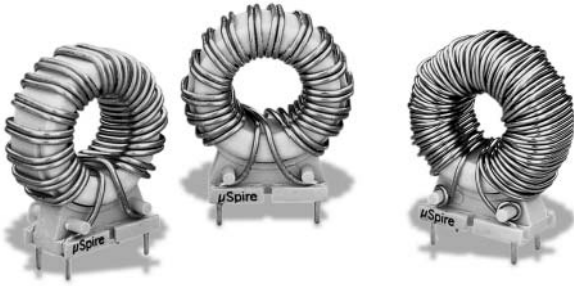

- Energy storage, smoothing, filtering
- Low drop in inductance under load
- Low leakage and high efficiency
- Thermoplastic materials compliant with UL94-V0
- Frequency range up to 200 kHz
- Operating temperature range: -40 °C to +125 °C
- Possibility to use differential mode without trap

## Electrical Data

ID Code	In Adc	Ln µH	Lo µH	Rdc Ω	Pin Ø mm	S series
<b>500µJ</b>						
ESI10 M37 1V	1.5	372	550	140	0.71	S
ESI10 M23 1V	2	230	348	112	0.71	S
ESI10 M14 1V	2.5	140	208	84	0.71	S
ESI10 M37 1V	3	93	137	35	0.71	P
ESI10 M10 1V	3	100	150	60	0.8	S
ESI10 45K 1V	4	45	64	26	1	S
ESI10 M23 1V	4	57	87	28	0.71	P
ESI10 M14 1V	5	35	52	21	0.71	P
ESI10 M10 1V	6	25	38	15	0.80	P
ESI10 45K 1V	8	11	16	6	1	P
<b>1500µJ</b>						
ESI20 M72 1V	2	720	1140	192	0.80	S
ESI20 M47 1V	2.5	475	755	136	0.85	S
ESI20 M63 1V	2.8	632	1300	200	0.8	S
ESI20 M31 1V	3	310	476	78	1	S
ESI20 M42 1V	3.5	420	875	130	0.90	S
ESI20 M17 1V	4	170	262	48	1.12	S
ESI20 M72 1V	4	180	285	48	0.8	P
ESI20 M25 1V	4.5	254	540	84	1	S
ESI20 M47 1V	5	119	190	34	0.85	P
ESI20 M63 1V	5.6	158	325	50	0.80	P
ESI20 M31 1V	6	77	120	19	1	P
ESI20 M14 1V	6	144	310	52	1.12	S
ESI20 M42 1V	7	105	219	32	0.9	P
ESI20 M17 1V	8	42	66	12	1.12	P
ESI20 M25 1V	9	63	135	21	1	P
ESI20 M14 1V	12	36	77	13	1.12	P
<b>2500µJ</b>						
ESI30 80K 1V	6	80	128	21	1	S
ESI30 48K 1V	7.5	48	84	13	1.12	S
ESI30 70K 1V	8.5	70	144	17	1	S
ESI30 46K 1V	10.5	46	96	14	1.12	S
ESI30 80K 1V	12	20	32	5	1	P
ESI30 48K 1V	15	12	20	3	1.12	P
ESI30 70K 1V	17	17.5	36	4	1	P
ESI30 46K 1V	21	11.5	24	3.5	1.12	P

## Connections

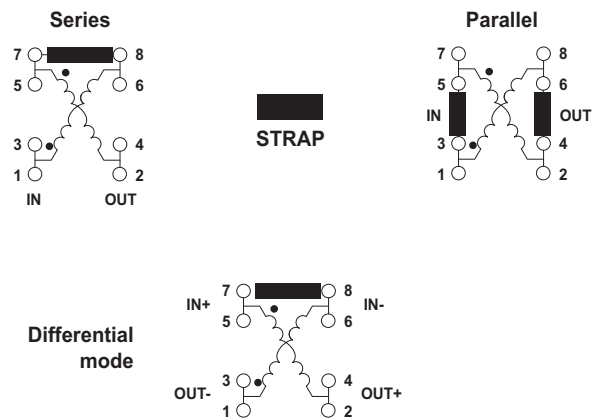

## Typical Dimensions (mm)

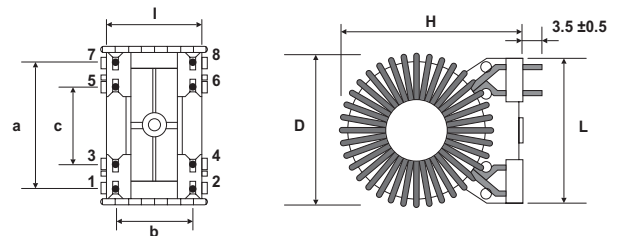

ID Code	L	I	H	D	a	b	c
ESI10	19.1	14	31.5	28	15.24	7.62	5.08
ESI20	29.1	22	40	36	25.4	15.24	15.24
ESI30	29.1	24	42	36	25.4	15.24	15.24

## Symbols

- S = two single windings in series
- P = two single windings in parallel
- In = Rated DC current
- Ln = Inductance under DC bias by In
- Lo = Inductance without DC bias
- Rdc = DC resistance of windings
- Pin Ø = Diameter of connection pin

